

# DESICCANT AIR DRYERS FOR SUPERIOR PRODUCTIVITY



CD<sup>+</sup> series (25-1400 l/s, 53-2968 cfm)  
BD<sup>+</sup> series (100-3000 l/s, 212-6360 cfm)  
XD<sup>+</sup> series (550-3600 l/s, 1165-7628 cfm)

*Atlas Copco*



The image shows two large, grey, vertical cylindrical desiccant dryers in an industrial setting. They are connected to a network of stainless steel pipes with various valves and fittings. A white control panel is mounted on the right-hand dryer. The panel features a small color LCD screen displaying a graphical interface with various data points and a red emergency stop button to its right. Below the screen, the text 'BD 1100+' and the 'Atlas Copco' logo are printed. The background is a light-colored brick wall.

# **COMPLETE PROTECTION FOR YOUR APPLICATION**

Dry and clean compressed air is essential for a broad range of industrial applications. Yet it must be produced reliably, energy-efficiently and cost-effectively. Atlas Copco's desiccant dryers protect your systems and processes. Their robust design ensures they operate with total reliability and deliver a constant, stable dewpoint in full load conditions and even during a temporary overload.



## **Protecting your reputation and production**

Compressed air entering the air net is always 100% saturated. When it cools, this moisture will condense, causing damage to your air system and finished products. Removing moisture from compressed air with a pressure dewpoint (PDP) as low as  $-70^{\circ}\text{C}/-100^{\circ}\text{F}$ , Atlas Copco desiccant dryers eliminate system failures, production downtime and costly repairs.

## **Highest reliability**

- A constant pressure dewpoint down to  $-70^{\circ}\text{C}/-100^{\circ}\text{F}$  at 100% load conditions.
- A proven, durable design for the switching valves significantly improves the dryer lifetime.
- An advanced control and monitoring system ensures production efficiency.

## **Maximum energy efficiency**

Atlas Copco's desiccant dryers incorporate energy-saving features to cut your carbon footprint. A low pressure drop below 0.2 bar/2.9 psi drives down energy costs. Dewpoint sensing and control adapts the energy consumption to the real load of the dryer. An adjustable PDP setpoint enables you to adapt the dryer to your actual needs.

## **Easy installation and long maintenance intervals**

The dryers have a small footprint thanks to an innovative all-in-one design. Delivered ready for use, installation is straightforward, minimizing costly production downtime.

## **Assuring your peace of mind**

All internal components are easily accessible to facilitate maintenance. The use of high-grade desiccant and durable valves extends maintenance intervals beyond the standard three years.

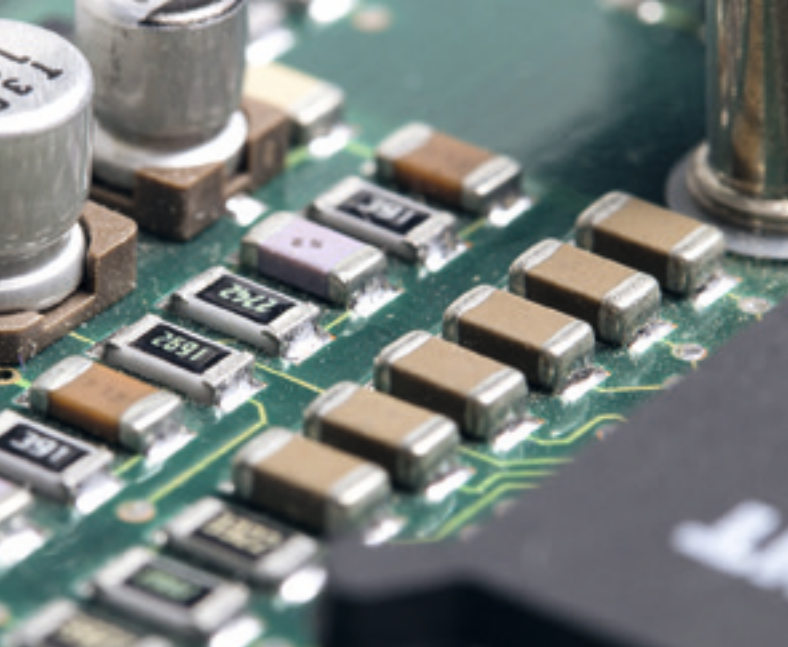

# ***THE RIGHT DESICCANT DRYER FOR YOUR APPLICATION***

A dry compressed air system is essential to maintain the reliability of production processes and the quality of end products. Untreated air can cause corrosion in pipe work, premature failure of pneumatic equipment, and product spoilage. Atlas Copco's desiccant dryers protect your systems and processes by producing superior dry compressed air in a reliable and energy-efficient way.



## **Electronics**

- High-quality dry compressed air is a must to remove microscopic debris from the surfaces of computer chips and boards.
- Moisture contamination is avoided: no oxidation of micro-terminal strips.
- A continuous flow of dry compressed air at a dewpoint as low as  $-70^{\circ}\text{C}/100^{\circ}\text{F}$ .

## **Food & beverage**

- A reliable source of dry compressed air for the preparation and processing of food and beverages.
- Any kind of moisture is eliminated: the free and easy movement of ingredients, items or food/beverage is guaranteed.

## **Oil & gas**

- Particularly for offshore, high-quality dry compressed air is critical.
- Full protection of your production continuity.
- A continuous supply of dry compressed air available 24/7 at a low dewpoint.

## **Pharmaceuticals**

- A consistent flow of high-quality dry compressed air is vital in the processing and manufacturing of most pharmaceuticals.
- Eliminating any moisture is critical to produce pharmaceuticals as some materials have a physical affinity for moisture.

# SUPERIOR ENERGY EFFICIENCY

A dryer's energy consumption mainly goes to internal pressure drops and the regeneration process. The key for designing desiccant dryers is therefore to keep the pressure drop as low as possible, and to develop technologies that allow regeneration to be as efficient as possible. Atlas Copco's dryers are designed to have a very low internal pressure drop below 0.2 bar/2.9 psi, and provide the most efficient regeneration process.

## Low pressure drop saves energy and reduces operating costs

If a desiccant dryer experiences a high internal pressure drop, the compressor discharge pressure must be set higher than required, which wastes energy and increases operating costs. Atlas Copco has therefore put considerable efforts into minimizing pressure drops in its dryers. The result is that most CD<sup>+</sup>, BD<sup>+</sup> and XD<sup>+</sup> desiccant dryers have a pressure drop below 0.2 bar/2.9 psi.

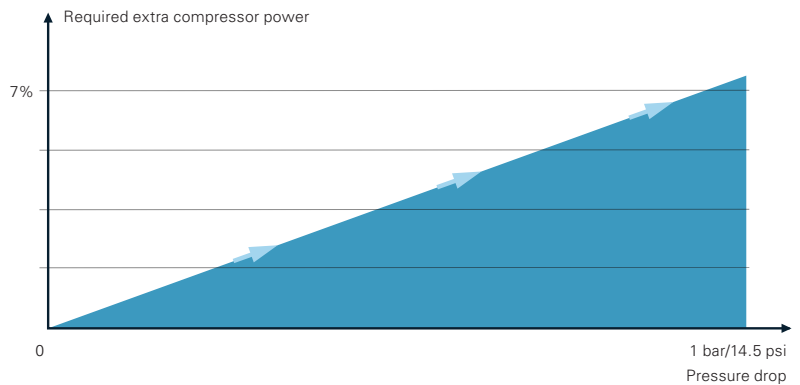

## Efficient regeneration due to Dewpoint Dependent Switching

Atlas Copco's CD<sup>+</sup>, BD<sup>+</sup> and XD<sup>+</sup> desiccant dryers incorporate state-of-the-art energy management control with built-in Dewpoint Dependent Switching. This makes the dryers more efficient, leading to energy savings of up to 90%, depending on installation and usage.

The principle is simple. Although the regeneration time remains constant, the delay before switching from one tower to the other is controlled via the PDP sensor. This is connected to a hygrometer which precisely measures the remaining humidity in the outlet compressed air. As soon as the target PDP is reached, the dryer cycle that was on hold will resume by switching to the dry tower. Delaying cycles in this way leads to major energy savings. This occurs when operating conditions are lower than reference, or the flow fluctuates below maximum nominal load.

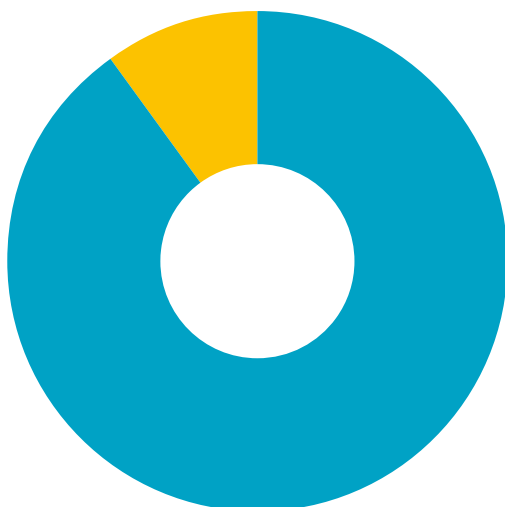

Typical dryer

- Pressure drop (on average 10%)
- Regeneration (on average 90%)

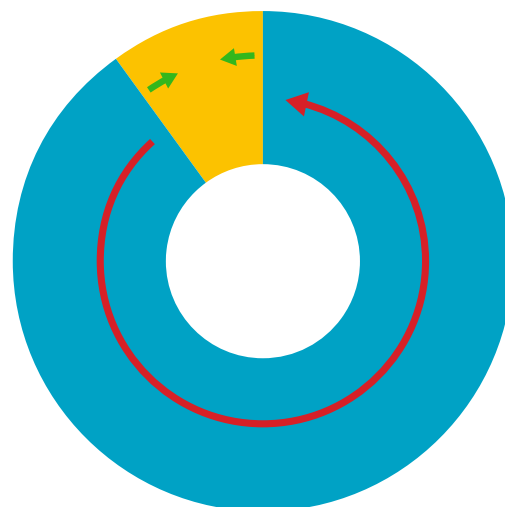

Atlas Copco dryer

- ➔ Reduced pressure drop below 0.2 bar/2.9 psi
- ➔ Dewpoint Dependent Switching for energy savings up to 90%

# HOW DOES A DESICCANT DRYER WORK?

Wet air passes directly through the desiccant medium which adsorbs the moisture. The desiccant medium has a finite capacity for adsorbing moisture before it must be dried out, or regenerated. To do this, the tower containing saturated desiccant medium is depressurized and the accumulated water is driven off. How this happens depends on the type of desiccant dryer:

- Heatless dryers use only compressed air as a purge.
- Blower purge dryers use a combination of air from an external blower, heat and minimal compressed air.
- Heat of compression dryers use the heat of the compression.

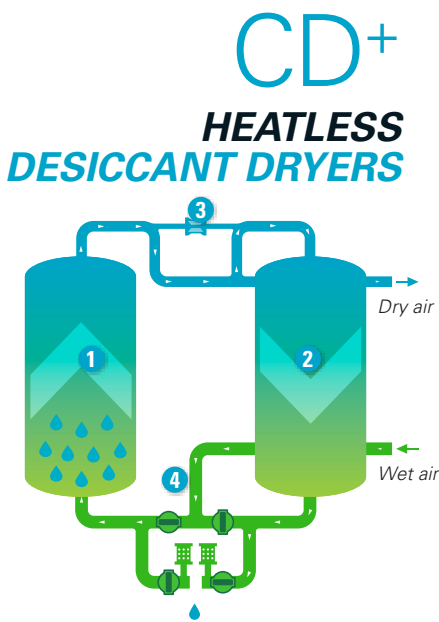

## The drying process

- 1 Wet compressed air flows upward through the desiccant which adsorbs the moisture, from bottom to top.

## The regeneration process

- 2 Dry air from the outlet of the drying tower is expanded to atmospheric pressure and sent through the saturated desiccant, forcing the adsorbed moisture out.
- 3 After desorption, the blow-off valve is closed and the vessel is re-pressurized.

## Switching

- 4 After regeneration, the functions of both towers are switched.

## The drying process

- 1 Wet compressed air flows upward through the desiccant which adsorbs the moisture, from bottom to top.

## The regeneration process

- 2 The blower takes ambient air
- 3 and blows it over the external heater.
- 4 The heated air is then sent through the saturated desiccant, forcing the adsorbed moisture out, from top to bottom.

## Switching

- 5 After regeneration, the functions of both towers are switched.

## Cooling

**Zero purge:** After the heating, the hot tower desiccant is cooled. Cooling is done by sending air from the hot vessel over a cooler and back into the hot tower, from bottom to top.

**Purge:** After the heating, the hot tower desiccant is cooled. Cooling is done by expanding dry compressed air from the outlet of the adsorbing vessel over the hot re-activated tower, from top to bottom.

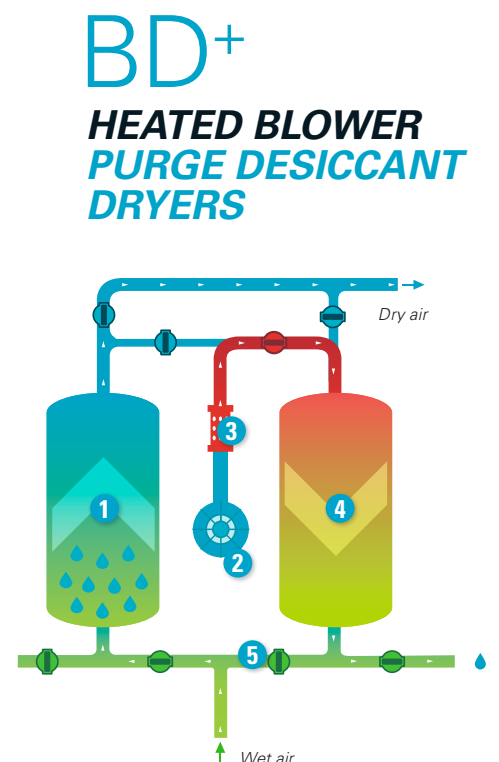

Atlas Copco's XD+ adsorption dryers use the heat of compression from oil-free compressors to dry compressed air. This heat is used effectively to regenerate the high quality desiccant, significantly reducing energy and operating costs. As any need for outside energy supply can be eliminated, adsorption is by far the most economical method of compressed air drying.

## XD+ HEAT OF COMPRESSION DESICCANT DRYERS (WITH ZERO PURGE COOLING)

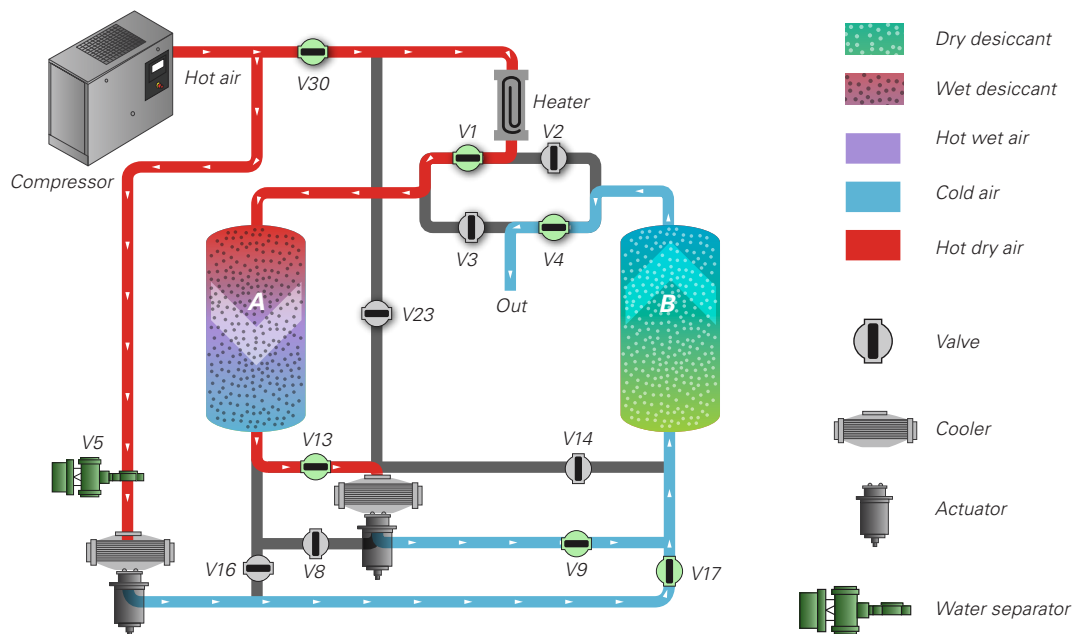

### XD+-G MODELS:

Combine heat of compression re-activated adsorption and internal heaters to achieve a constant pressure dewpoint of -40°C / -70°C or lower, regardless of ambient conditions.

### XD+-S MODELS:

Use the heat of compression for regeneration and feature dewpoints of -10°C to -20°C, dependent upon ambient conditions. When combined with the high outlet temperatures of a ZR compressor, XD+-S Purge models can achieve a dewpoint of -40°C.

Both models are available as single inlet and double inlet variant.

### Relative life cycle cost of the dryers over a 10-year period

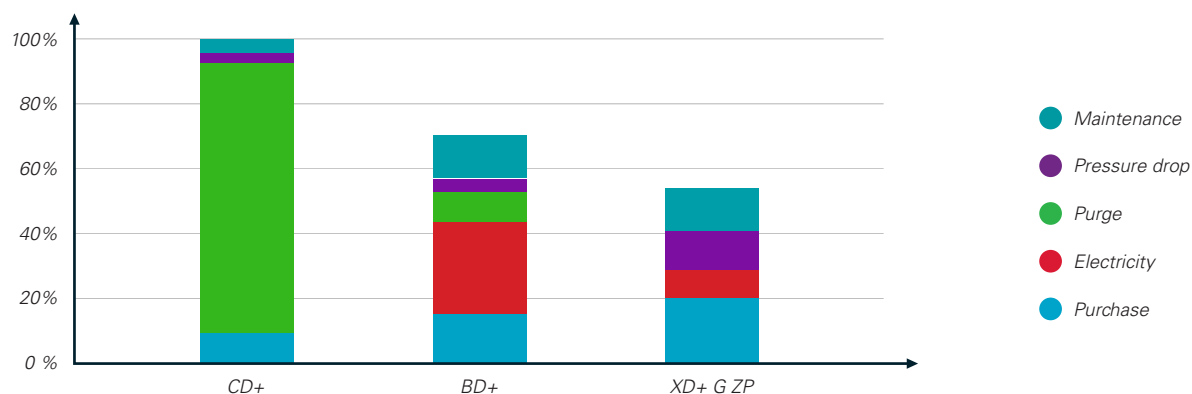

# CD 25<sup>+</sup>-145<sup>+</sup>: RELIABLE AND COMPACT

1

## Filters

- Pre-filter(s) protect desiccant against oil contamination, increasing desiccant lifetime.
- After-filter protects network against desiccant dust, avoiding network contamination.
- Can be mounted directly on the inlet and outlet of the dryer, for low pressure drop.
- Easy to assemble and maintain as no extra piping or filter connections are required.

2

## High-quality valve block with few moving parts

Designed to minimize pressure drop and increase reliability.



3

## Overfilled and spring-loaded high-performance desiccant cartridges

- Pressure dewpoint of -40°C/-40°F as standard (-70°C/-100°F as option).
- Filter mat increases silencer lifetime by preventing dust exiting during regeneration.
- Overfilled cartridges protect against desiccant ageing and overflow peak.
- Horizontal operation possible.

4

## Up-sized silencers with integrated safety valves

Advanced mufflers avoid back-pressure, increase purge efficiency, offer protection in case of clogging via the integrated safety valve, and reduce noise level during blow-off.







5

### Advanced control and monitoring system

- Timer control variant cycles defined to reach PDP target even at 100% load.
- Auto restart after power failure function with cycle status memory.
- Full status annunciation on LEDs, display and pressure gauges.
- Remote alarm and remote control.
- Purge Saver contact: the dryer can freeze purge cycle in case of unload/stop signal.
- All controls are protected from water and dust thanks to the IP54 cubicle.

6

### Dewpoint Dependent Switching (optional)

- Real PDP monitoring (hygrometer).
- PDP display on controller (and alarm).
- The dryer will only switch to the next tower when the desiccant is saturated (based on PDP input). During that period, the dryer consumes no purge.



### Corrosion protected design

Base, heads, panels, valves and extrusion profiles are corrosion protected, increasing dryer lifetime.

# CD 110<sup>+</sup>-1400<sup>+</sup>: OUTSTANDING RELIABILITY AND AVAILABILITY



1

## Up-sized silencers with integrated safety valves

Advanced mufflers avoid back-pressure, increase purge efficiency, offer protection in case of clogging via the integrated safety valve, and reduce noise level during blow-off.



## Filters

- Pre-filter(s) protect desiccant against oil contamination, increasing desiccant lifetime.
- After-filter protects network against desiccant dust, avoiding network contamination.
- Can be mounted directly on the inlet and outlet of the dryer, for low pressure drop.
- Easy to assemble and maintain as no extra piping or filter connections are required.

## High-quality desiccant

- Pressure dewpoint of -40°C/-40°F as standard (-70°C/-100°F as option).
- Up to 30% extra desiccant overfill to deliver consistent performance even in harsh conditions such as high temperatures and temporary overloads.

## Robust and compact design

- Standard frame, including forklift slots and lifting eyes for easy handling.
- Wide vessels ensure a low air speed and a longer contact time.
- Flanges connecting vessels are integrated into the top and bottom shells, lowering the total unit height.





## 2 Dewpoint Dependent Switching

- Real PDP monitoring (hygrometer).
- PDP display on controller (and alarm).
- The dryer will only switch to the next tower when the desiccant is saturated (based on PDP input). During that period, the dryer consumes no purge.

## 3 Galvanized piping with flanged connections

- Flanged piping simplifies maintenance and minimizes the chance of leakage.
- Pipe sizing is optimized to ensure a low pressure drop, resulting in energy savings.



## 4 Advanced control and monitoring system

- Fitted inside a real IP54 cubicle for easy cabling and safety.
- Monitors all parameters to ensure maximum reliability of the installation.



## 5 Stainless steel valves

Fully stainless steel high-performance butterfly valves with actuators ensure long lifetime.

# BD 100<sup>+</sup>-3000<sup>+</sup>: ROCK-SOLID RELIABILITY & COST-EFFICIENCY



1

## Stainless steel valves

Fully stainless steel high-performance butterfly valves with actuators ensure long lifetime.

2

## Advanced control and monitoring system

- Fitted inside a real IP54 cubicle for easy cabling and safety.
- Monitoring all parameters to ensure maximum reliability of installation.

3

## Low-wattage density heater

- Stainless steel design ensures long lifetime.
- Nickel-plated heater pipe protects against corrosion.
- Heater is installed in an insulated heater pipe for most energy-efficient setup.
- Optionally insulated vessels are available to further reduce heat losses and increase overall efficiency (standard on the -70°C/-100°F variant).



4

## Dewpoint Dependent Switching

- Real PDP monitoring (hygrometer).
- PDP display on controller (and alarm).
- The dryer will only switch to the next tower when the desiccant is saturated (based on PDP input). During that period, the dryer consumes no energy.





### 5 Galvanized piping with flanged connections

- Flanged piping simplifies maintenance and minimizes the chance of leakage.
- Pipe sizing is optimized to ensure a low pressure drop, resulting in energy savings.

### Long-life silica gel desiccant

- High-adsorption silica gel desiccant needs less reactivation energy than other drying agents.
- 2-layer desiccant bed; a water-resistant bottom layer protects the high-performing top layer.
- Pressure dewpoint of  $-40^{\circ}\text{C}/-40^{\circ}\text{F}$  as standard ( $-70^{\circ}\text{C}/-100^{\circ}\text{F}$  as option).
- Up to 30% extra desiccant overfill to deliver consistent performance even in harsh conditions such as high temperatures and temporary overloads.

### Filters

- Pre-filter(s) protect desiccant against oil contamination, increasing desiccant lifetime.
- After-filter protects network against desiccant dust, avoiding network contamination.
- Can be mounted directly on the inlet and outlet of the dryer, for low pressure drop.
- Easy to assemble and maintain as no extra piping or filter connections are required.



### Robust and compact design

- Standard frame, including forklift slots and lifting eyes for easy handling.
- Wide vessels ensure a low air speed and a longer contact time.
- Flanges connecting vessels are integrated into the top and bottom shells, lowering the total unit height.

# ***XD 550<sup>+</sup>-3600<sup>+</sup>: STATE-OF-THE-ART, ENERGY-EFFICIENT DRYING***

1

## **Stainless steel internal heaters\***

- By generating heat only when needed, energy losses are limited.
- Overheating protection and control by Elektronikon on each heater bundle.
- The heated air does not need to pass through any valves, ensuring a reduced chance of valve failure.

*\* Only for G-variants.*



2

## **Advanced control and monitoring system**

- Fitted inside a real IP54 cubicle for easy cabling and safety.
- Monitors all parameters to ensure maximum reliability of the installation.

3

## **Drying towers**

- Reduced pressure drop.
- Built-in water separator to reduce desiccant load and extend the drying cycle.
- Oversized.
- Full size stainless steel strainer.
- Reversed internal flow for optimal flow distribution.



4

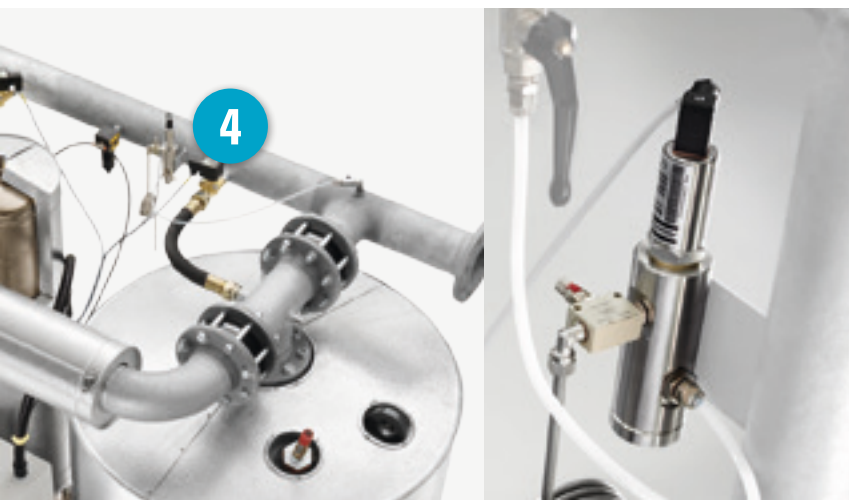

4

## **Dewpoint Dependent Switching**

- Real PDP monitoring (hygrometer).
- PDP display on controller (and alarm).
- The dryer will only switch to the next tower when the desiccant is saturated (based on PDP input). During that period, the dryer consumes no energy.



### Water-resistant desiccant

- Low desorption temperature and energy consumption.
- Easy filling and access via manholes/blind flanges.
- Extended lifetime.

### Hot air inlet

- Heat of compression used for regeneration.
- No energy consumption.



### Electronic water drains with standard alarm

- No loss of compressed air.
- Maintenance-free and trouble-free operation.
- Manual drains allow for easy servicing while in operation.

### Stainless steel coolers

- Maximum energy efficiency and extended lifetime.
- Guaranteed easy inspection and maintenance.
- Low pressure drop.
- High water separation.
- Bundles can be rodded in place.

# A STEP AHEAD IN CONTROL AND MONITORING

Atlas Copco's Elektronikon® control and monitoring system takes continuous care of your desiccant dryer to ensure optimal productivity and efficiency at your site.



## User-friendly interface

Available in 32 languages, this graphical 3.5-inch high-definition color display with pictograms and LED indicators for key events is easy to use. The keyboard is durable to resist tough treatment in demanding environments.

## Comprehensive maintenance display

Valuable items of information displayed include the ServicePlan indicator and preventive maintenance warnings.

## Internet-based visualization

The Elektronikon® system monitors and displays key parameters such as dewpoint, vessel pressure and inlet temperature, and includes an energy-savings indicator. Internet-based visualization of your dryer is possible by using a simple Ethernet connection.



## SMARTLINK\*

- Remote monitoring system that helps you optimize your compressed air system and save energy and costs.
- Provides a complete insight in your compressed air network.
- Anticipates on potential problems by warning you up-front.

*\* Please contact your local sales representative for more information.*



# OPTIMIZE YOUR SYSTEM

## Scope of supply

Air circuit	Stainless steel butterfly valves
	Galvanised in- and outlet piping
	In- and outlet air flanges
	Insulated heater pipe and connection pipe to vessels*
Connections	DIN-flanges / ANSI-flanges
Electrical components	Pre-mounted electrical cubicle
	Elektronikon control and monitoring system
	IP54 protected
	Voltage free contacts for remote alarm and warning signals
Framework	Pressure dewpoint sensor and control
	Base frame with forklift slots
Mechanical approval	Lifting holes
	PED approval / ASME approval

\*Not on CD\*

## Options

	CD 1* - CD 25*	CD 25* - CD 145*	CD 100* - CD 300*	CD 330* - CD 1400*	BD 100 - BD 300 Purge	BD 330* - BD 3000* Purge	BD 330* - BD 3000* Zero Purge	XD 550* - XD 3600*
Maximum working pressure 10 bar(g)	-	-	-	-	-	-	-	✓
Maximum working pressure 14.5 bar(e)/210 psig	-	✓	•	•	✓	•	•	-
PDP sensor and control	•	✓	✓	✓	✓	✓	✓	✓
2nd PDP read out	-	-	-	•	-	•	•	•
-70°C/-100°F pressure dewpoint	-	•	•	•	•	-	•	-
Pre- and after-filter package for GA oil-injected compressors	-	✓	✓	•	✓	•	•	-
Pre- and after-filter package for Z oil-free compressors	-	-	-	•	-	•	•	-
After-filter package	-	-	-	-	-	-	-	•
Pressure relief valves	-	-	-/✓	•	✓	•	•	✓
Sonic nozzle	-	-/•	•	•	•	•	•	•
GSM connect	-	-	-	•	-	•	•	-
High inlet temperature variant	-	-	•	•	-	•	•	-
High ambient temperature variant	-	-	-	-	-	•	•	•
Dryer tower insulation	-	-	-	-	•	•	•	•
Optimized purge nozzle (4/5.5/8.5/10 bar(e) - 58/80/123/145 psig)	-	✓	•	•	-	•	-	-
Blower inlet filter	-	-	-	-	•	•	•	-
External pilot air connection for low pressure inlet	-	-	-	-	-	•	•	•

✓ : Standard    • : Optional    - : Not available

## Dessicant dryer range

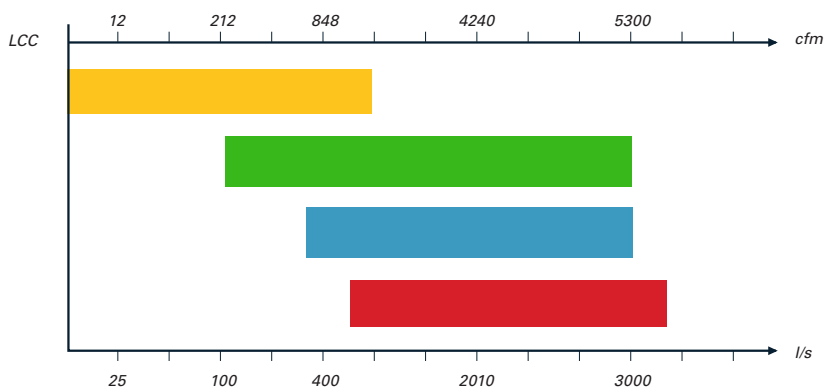

\* Zero purge cooling

# TECHNICAL SPECIFICATIONS

## Heatless desiccant dryers

DRYER TYPE	Inlet flow FAD 7bar(e)/100 psig(1)			Pressure drop (excluding filters)		Inlet / outlet connections 50 Hz: G/ PN16 60 Hz: NPT/ DN	Filter sizes (recommended)				Dimensions						Weight	
	l/s	m³/hr	cfm	bar	psi		Pre-filters			After-filter	mm			in			kg	lbs
							1 µm 0.1 ppm	0.01 µm 0.01 ppm	0.01 µm 0.01 ppm	1 µm	L	W	H	L	W	H		
CD 1+	1	4	2	0.2	2.90	1/4"	N.A.	PD3		Integrated	106	172	540	7	4	21	7	15
CD 1.5+	1.5	5	3	0.2	2.90	1/4"	N.A.	PD3		Integrated	106	172	590	7	4	23	8	17
CD 2+	2	8	4	0.2	2.90	1/4"	N.A.	PD3		Integrated	106	172	720	7	4	28	9	19
CD 2.5+	2.5	9	5	0.2	2.90	1/4"	N.A.	PD3		Integrated	106	172	830	7	4	32	10	22
CD 3+	3	11	6	0.2	2.90	1/4"	N.A.	PD3		Integrated	106	172	855	7	4	33	11	24
CD 5+	5	18	11	0.2	2.90	½"	N.A.	PD9		Integrated	149	295	640	11	6	25	19	41
CD 7+	7	25	15	0.2	2.90	½"	N.A.	PD9		Integrated	149	295	730	11	6	28	22	48
CD 10+	10	36	21	0.2	2.90	½"	N.A.	PD9	UD 9+	Integrated	149	295	875	11	6	34	25	55
CD 12+	12	43	25	0.2	2.90	½"	N.A.	PD17	UD 15+	Integrated	149	295	1015	11	6	40	29	63
CD 17+	17	61	36	0.2	2.90	½"	N.A.	PD17	UD 15+	Integrated	149	295	1270	11	6	50	35	77
CD 22+	22	79	47	0.35	5.08	½"	N.A.	PD17	UD 25+	Integrated	149	295	1505	11	6	59	44	97
CD 25+	25	90	53	0.06	0.87	½"	DD32	PD32	UD 25+	DDp32	550	201	1233	21.7	7.9	48.5	50	110
CD 30+	30	108	64	0.085	1.23	½"	DD32	PD32	UD 45+	DDp32	550	201	1233	21.7	7.9	48.5	50	110
CD 35+	35	126	74	0.095	1.38	½"	DD32	PD32	UD 45+	DDp32	550	201	1478	21.7	7.9	58.2	60	132
CD 50+	50	180	106	0.35	5.08	1"	DD60	PD60	UD 60+	DDp60	550	201	1846	21.7	7.9	72.7	80	176
CD 60+	60	216	127	0.12	1.74	1"	DD60	PD60	UD 60+	DDp60	550	364	1233	21.7	14.3	48.5	100	220
CD 70+	70	252	148	0.16	2.32	1"	DD60	PD60	UD 60+	DDp60	550	364	1479	21.7	14.3	58.2	120	265
CD 80+	80	288	170	0.12	1.74	1½"	DD120	PD120	UD 100+	DDp120	550	364	1846	21.7	14.3	72.7	160	353
CD 100+	100	360	212	0.35	5.08	1½"	DD120	PD120	UD 100+	DDp120	550	364	1846	21.7	14.3	72.7	160	353
CD 145+	145	522	307	0.35	5.08	1½"	DD150	PD150	UD 140+	DDp150	550	526	1846	21.7	20.7	72.7	240	529
CD 110+	110	396	233	0.12	1.74	1½"	DD120	PD120	UD 100+	DDp120	950	728	1695	37.4	28.7	66.7	340	750
CD 150+	150	540	318	0.16	2.32	1½"	DD150	PD150	UD 140+	DDp150	1089	848	1731	42.9	33.4	68.1	415	915
CD 185+	185	666	392	0.2	2.90	1½"	DD175	PD175	UD 180+	DDp175	1089	848	1731	42.9	33.4	68.1	445	981
CD 250+	250	900	530	0.14	2.03	2"	DD280	PD280	UD 310+	DDp280	1106	960	1816	43.5	37.8	71.5	600	1323
CD 300+	300	1080	636	0.19	2.76	2"	DD280	PD280	UD 310+	DDp280	1173	1116	1854	46.2	43.9	73.0	650	1433
CD 330+	330	1188	700	0.1	1.45	DN80	DD425+	PD425+	UD 425+	DDp425+	1088	1776	2537	43	69.92	99.88	950	2109
CD 400+	400	1440	848	0.1	1.45	DN80	DD425+	PD425+	UD 425+	DDp425+	1088	1776	2537	43	69.92	99.88	1030	2287
CD 550+	550	1980	1166	0.1	1.45	DN80	DD550+	PD550+	UD 550+	DDp550+	1091	1884	2592	43	74.17	102	1310	2908
CD 850+	850	3060	1802	0.1	1.45	DN100	DD850+	PD850+	UD 850+	DDp850+	1259	2359	2655	50	92.87	104.5	2120	4706
CD 1100+	1100	3960	2332	0.1	1.45	DN100	DD1100+	PD1100+	UD 1100+	DDp1100+	1259	2472	2637	50	97.32	103.8	2600	5772
CD 1400+	1400	5040	2968	0.11	1.60	DN125	DD1400+	PD1400+	UD 1400+	DDp1400+	1428	2693	2576	56	106	101.4	3700	8215

# TECHNICAL SPECIFICATIONS

## Blower purge desiccant dryers

DRYER TYPE	Inlet flow FAD 7bar(e)/ 100 psig(1)			Average power consumption		Pressure drop (excluding filters)		Inlet / outlet connections	Filter sizes (recommended)				Dimensions						Weight	
	l/s	m³/hr	cfm	kW	hp	bar	psi		50 Hz: G/ PN16 60 Hz: NPT/ DN	Pre-filters			After-filter	mm			in			kg
								1 µm 0.1 ppm		0.01 µm 0.01 ppm	0.01 µm 0.01 ppm	1 µm	L	W	H	L	W	H		
Purge Cooling																				
BD 100+	100	360	212	2.2	2.97	0.2	2.9	1 1/2"	DD120	PD120	UD 100*	DDp120	1250	770	1720	49.2	30.3	68	640	1421
BD 150+	150	540	318	3.3	4.5	0.2	2.9	1 1/2"	DD150	PD150	UD 140*	DDp150	1300	870	1770	51.2	34.3	70	680	1510
BD 185+	185	666	392	3.5	4.7	0.2	2.9	1 1/2"	DD175	PD175	UD 180*	DDp175	1300	870	1770	51.2	34.3	70	710	1576
BD 250+	250	900	530	4.8	6.5	0.2	2.9	2"	DD280	PD280	UD 310*	DDp280	1345	955	1816	53.0	37.6	71	775	1721
BD 300+	300	1080	636	5.7	7.7	0.2	2.9	2"	DD280	PD280	UD 310*	DDp280	1425	1010	1853	56.1	39.8	73	820	1821
BD 330+	330	1188	700	9.3	12.6	0.12	1.74	80	DD425*	PD425*	UD 425*	DDp425*	1764	1024	2558	69.4	40.3	101	1190	2642
BD 400+	400	1440	848	10.2	13.8	0.12	1.74	80	DD425*	PD425*	UD 425*	DDp425*	1764	1024	2558	69.4	40.3	101	1300	2886
BD 550+	550	1980	1166	12	16.2	0.12	1.74	80	DD550*	PD550*	UD 550*	DDp550*	1884	1024	2612	74.2	40.3	103	1620	3597
BD 850+	850	3060	1802	17.1	23.1	0.12	1.74	100	DD850*	PD850*	UD 850*	DDp850*	2359	1175	2702	92.9	46.3	106	2600	5773
BD 1100+	1100	3960	2332	24.2	32.7	0.12	1.74	100	DD1100*	PD1100*	UD 1100*	DDp1100*	2472	1175	2681	97.3	46.3	106	3040	6750
BD 1400+	1400	5040	2968	33	44.55	0.1	1.45	150	DD1400*	PD1400*	UD 1400*	DDp1400*	2720	2199	2548	107.1	86.6	100	4100	9103
BD 1800+	1800	6480	3816	39	52.65	0.16	2.32	150	DD1800*	PD1800*	UD 1800*	DDp1800*	2793	2199	2548	110.0	86.6	100	4700	10435
BD 2200+	2200	7920	4664	55	74.25	0.22	3.19	150	DD2200*	PD2200*	UD 2200*	DDp2200*	2993	2199	2548	117.8	86.6	100	5600	12433
BD 3000+	3000	10800	6360	69	93.15	0.18	2.61	150	DD3000*	PD3000*	UD 3000*	DDp3000*	3350	2417	2893	131.9	95.2	114	7600	16874
Zero purge cooling																				
BD 330+	330	1188	700	8.6	11.6	0.12	1.74	80	DD425*	PD425*	UD 425*	DDp425*	1764	1024	2558	69.4	40.3	101	1420	3153
BD 400+	400	1440	848	10.7	14.4	0.12	1.74	80	DD425*	PD425*	UD 425*	DDp425*	1764	1024	2558	69.4	40.3	101	1545	3430
BD 550+	550	1980	1166	13.2	17.8	0.12	1.74	80	DD550*	PD550*	UD 550*	DDp550*	1884	1024	2612	74.2	40.3	103	1910	4241
BD 850+	850	3060	1802	23.4	31.6	0.12	1.74	100	DD850*	PD850*	UD 850*	DDp850*	2359	1175	2702	92.9	46.3	106	2960	6572
BD 1100+	1100	3960	2332	32.4	43.7	0.12	1.74	100	DD1100*	PD1100*	UD 1100*	DDp1100*	2472	1175	2681	97.3	46.3	106	3490	7745
BD 1400+	1400	5040	2968	37	50.0	0.1	1.45	150	DD1400*	PD1400*	UD 1400*	DDp1400*	2720	2639	2548	107.1	103.9	100	4450	9880
BD 1800+	1800	6480	3816	45	60.8	0.16	2.32	150	DD1800*	PD1800*	UD 1800*	DDp1800*	2793	2663	2548	110.0	104.8	100	5050	11213
BD 2200+	2200	7920	4664	62	83.7	0.22	3.19	150	DD2200*	PD2200*	UD 2200*	DDp2200*	2993	2775	2548	117.8	109.3	100	5950	13211
BD 3000+	3000	10800	6360	79	106.7	0.18	2.61	150	DD3000*	PD3000*	UD 3000*	DDp3000*	3350	2923	2893	131.9	115.1	114	7950	17651

## Heat of compression desiccant dryers

DRYER TYPE	Inlet flow FAD 7bar(e)/ 100 psig(1)			Average power consumption		Pressure drop (excluding filters)		Inlet / outlet connections	Filter sizes (recommended)	Dimensions						Weight	
	l/s	m³/hr	cfm	kW	hp	bar	psi			50 Hz: G/ PN16 60 Hz: NPT/ DN	After-filter	mm			in		
								1 µm 0.1 ppm	L		W	H	L	W	H		
XD 550+	550	1980	1166	3.4	4.59	0.39	5.655	80	DDp550*	1884	1589	2612	74.2	62.6	103	2196	4876
XD 850+	850	3060	1802	5.1	6.9	0.39	5.655	100	DDp850*	2359	1936	2752	92.9	76.2	108	3320	7371
XD 1100+	1100	3960	2332	6.5	8.8	0.39	5.655	100	DDp1100*	2473	1936	2734	97.4	76.2	108	3835	8515
XD 1400+	1400	5040	2968	8.4	11.3	0.35	5.075	150	DDp1400*	4120	2290	2556	162	90.2	101	5921	13146
XD 1800+	1800	6480	3816	10.8	14.6	0.35	5.075	150	DDp1800*	4120	2292	2560	162	90.2	101	6550	14543
XD 2200+	2200	7920	4664	13.2	17.8	0.35	5.075	150	DDp2200*	4120	2292	2680	162	90.2	105.51	7365	16353
XD 3000+	3000	10800	6360	18	24.3	0.35	5.075	200	DDp3000*	5617	2724	2866	221	107	112.83	9531	21162
XD 3600+	3600	12960	7632	21.6	29.2	0.35	5.075	200	DDp4000*	5617	2724	2866	221	107	112.83	10390	23069

### Reference conditions:

Compressor air inlet temperature: 35°C / 100°F

Inlet relative humidity: 100%.

Dryer inlet pressure for 11 bar variants, after inlet filtration

## ***COMMITTED TO SUSTAINABLE PRODUCTIVITY***

We stand by our responsibilities towards our customers, towards the environment and the people around us. We make performance stand the test of time. This is what we call – Sustainable Productivity.



[www.atlascopco.com](http://www.atlascopco.com)

The Atlas Copco logo, consisting of the brand name 'Atlas Copco' in a stylized font, flanked by two horizontal bars above and below it.